



Finiture piano:

- marmo Calacatta, spessore 15 mm, sagomato e parzialmente incassato (5 mm a vista);
 - vetro temperato retroverniciato Nero, spessore 10 mm, sagomato e parzialmente incassato (5 mm a vista);
 - MDF, spessore 20 mm, impiallacciato frassino fiammato laccato a poro aperto color Liquirizia, sagomato e parzialmente incassato (5 mm a vista);
 - MDF, spessore 20 mm, impiallacciato ebano composto spazzolato laccato opaco a poro aperto, sagomato e parzialmente incassato (5 mm a vista);
 Sottopiano portante stratificato in MDF, laccato opaco colore Liquirizia.
 Il piano in marmo Calacatta è supportato da un pannello in alveolare di alluminio spessore 5 mm.
Base: in alluminio, composta da gambe unite mezzo telaio a crociera. Ulteriore telaio strutturale verniciato Liquirizia unito al sottopiano in MDF. La parte esterna delle gambe è verniciata opaco colore Liquirizia mentre la parte interna e il telaio a crociera sono verniciati lucido color Bronzo oppure in finitura Rame lucido.
 Piedini regolabili in metallo color Liquirizia con scivolanti protettivi in ABS.

Top finishes:

- Calacatta marble, 15 mm thick, contoured and partially recessed (5 mm exposed);
 - tempered Black backpainted glass, 10 mm thick, contoured and partially recessed (5 mm exposed);
 - MDF, 20 mm thick, flamed ash veneer with open-pore lacquer finish in Licorice colour, contoured and partially recessed (5 mm exposed);
 - MDF, 20 mm thick, composite ebony veneer, brushed open-pore matt lacquer finish, contoured and partially recessed (5 mm exposed);
 Laminated loadbearing under-panel in MDF, Licorice colour matt lacquer finish. The Calacatta marble top is supported by a 5 mm thick aluminum honeycomb panel.
Base: aluminium, comprised of legs joined by an elongated crosspiece. Additional structural frame, varnished Licorice colour, joined to MDF under-panel. The external-facing part of the legs is varnished matt Licorice colour while the interior-facing part and the crosspiece are varnished polished Bronze or polished Copper finish.
 Licorice colour adjustable metal feet with protective ABS glides.

Tischplatten:

- Calacatta Marmor, Stärke 15 mm, formgeschnitten und teilweise eingelegt (5 mm sichtbar);
 - rückseitig schwarz lackiertes gehärtetes Glas, Stärke 10 mm, formgeschnitten und teilweise eingelegt (5 mm sichtbar);
 - MDF, Stärke 20 mm, furniert mit geflammter Esche, offenporig lakritzefarbig lackiert, formgeschnitten und teilweise eingelegt (5 mm sichtbar);
 - MDF, Stärke 20 mm, furniert mit Ebenholzkompisit, gebürstet offenporig matt lackiert, formgeschnitten und teilweise eingelegt (5 mm sichtbar);
 - MDF, Stärke 20 mm, furniert mit Ebenholzkompisit, gebürstet offenporig matt lackiert, formgeschnitten und teilweise eingelegt (5 mm sichtbar);
 Tragende Unterplatte aus MDF Schichtholz, matt lakritzefarbig lackiert.
 Die Platte aus Calacatta Marmor wird von einer 5 mm Stärken Aluminium Wabenplatte gehalten.
Gestell: Aus Aluminium, die Beine sind über Querstreben kreuzförmig miteinander verbunden. Der obere Teil der Struktur ist matt lakritzefarbig lackiert und mit der MDF Unterplatte verbunden.
 Die Außenseiten der Beine sind lakritzefarbig matt lackiert, während die Innenseiten und das kreuzförmige Gestell glänzend bronzefarbig oder kupferfarbig lackiert sind.
 Verstellbare, lakritzefarbige Metallfüßchen mit Gleitschutz aus ABS.

Finitions du plateau :

- marbre Calacatta, épaisseur 15 mm, façonné et partiellement encastré (saillie 5 mm) ;
 - verre trempé rétro-laqué Noir, épaisseur 10 mm, façonné et partiellement encastré (saillie 5 mm) ;
 - MDF, épaisseur 20 mm, plaqué frêne flammé laqué à pores ouverts couleur Réglisse, façonné et partiellement encastré (saillie 5 mm) ;
 - MDF, épaisseur 20 mm, plaqué ébène composite brossée, laquée mat à pores ouverts, façonné et partiellement encastré (saillie 5 mm) ;
 Sous-plateau porteur en MDF stratifié, laqué mat couleur Réglisse.
 Le plateau en marbre Calacatta repose sur un panneau en nid d'abeille d'aluminium de 5 mm d'épaisseur.
Piètement : en aluminium, composé de pieds reliés par une entretoise. Bâti supplémentaire peint couleur Réglisse relié au sous-plateau en MDF.
 La partie extérieure des pieds est peinte mat couleur Réglisse, tandis que la partie intérieure des pieds et l'entretoise sont peints brillant couleur Bronze ou couleur Cuivre.
 Pieds réglables en métal couleur Réglisse avec patins glisseurs en ABS.

FINITURE PIANO TOP FINISHES

MARMO MARBLE

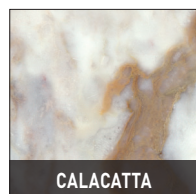

VETRO RETROVERNICIATO BACKPAINTED GLASS

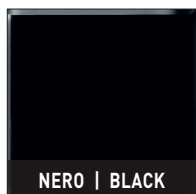

FRASSINO ASH



EBANO EBONY

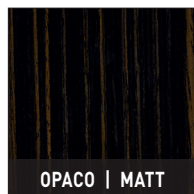

FINITURA SOTTOPIANO UNDER-PANEL FINISH

LACCATO OPACO MATT LACQUERED



FINITURA ESTERNA GAMBE EXTERNAL LEGS FINISH

ALLUMINIO ALUMINIUM



FINITURE INTERNE GAMBE E TELAIO INTERIOR LEGS AND CROSSPIECE FINISHES

ALLUMINIO ALUMINIUM

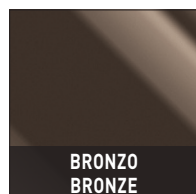

Minotti

PIANO MARMO CALACATTA CALACATTA MARBLE TOP

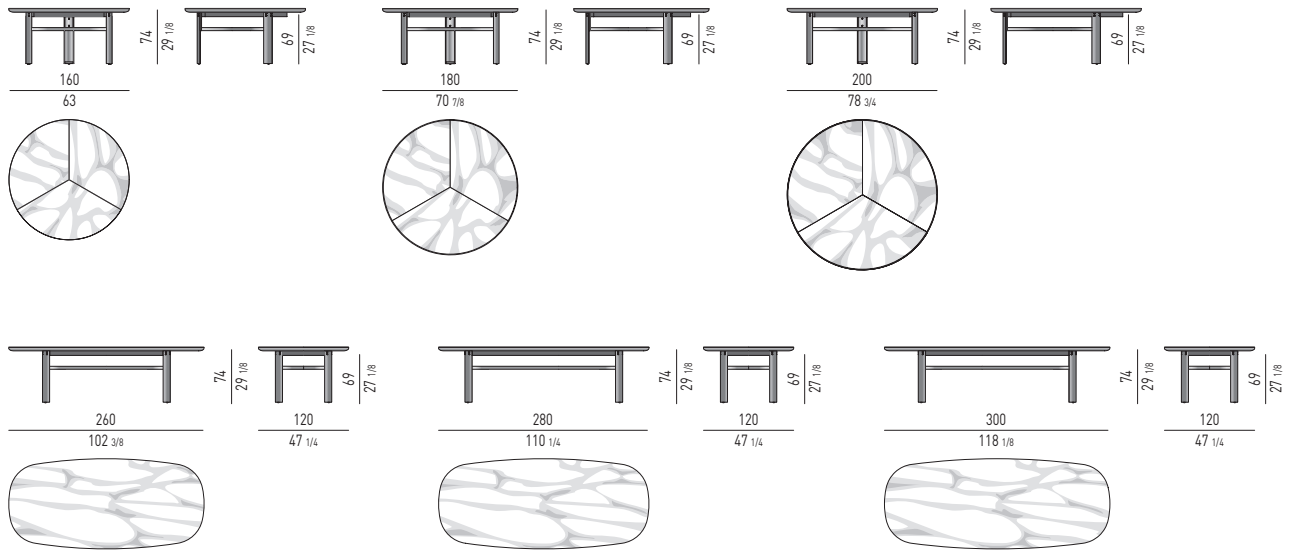

PIANO VETRO RETROVERNICIATO NERO BLACK BACKPAINTED GLASS TOP

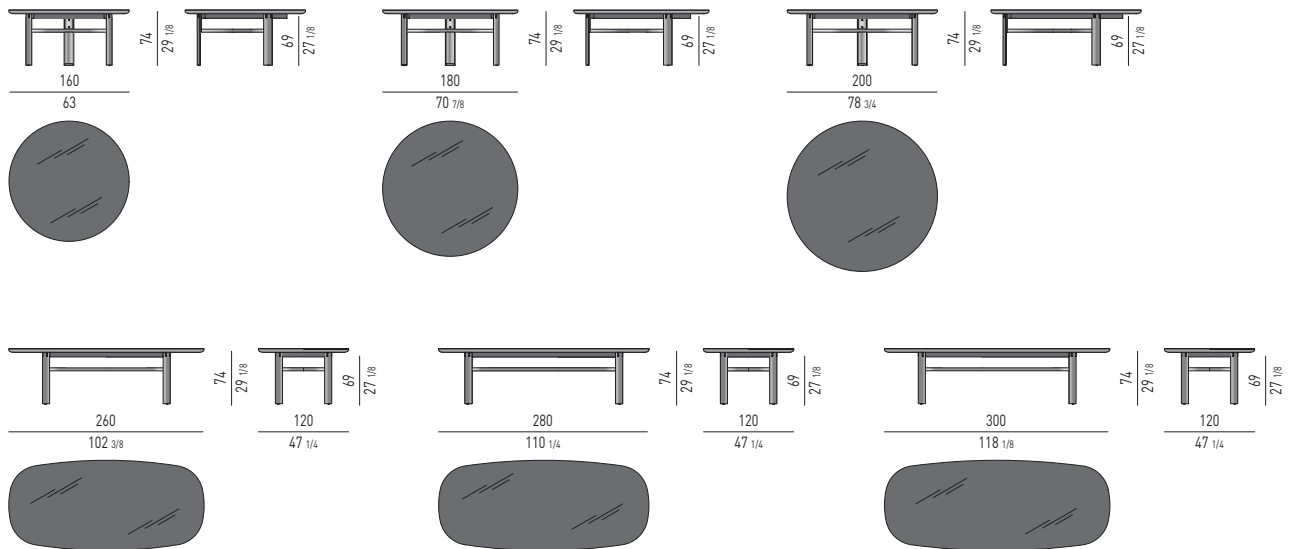

FINITURE INTERNE GAMBE E TELAIO INTERIOR LEGS AND CROSSPIECE FINISHES

BRONZO BRONZE



RAME LUCIDO POLISHED COPPER



POSIZIONE GAMBE | LEGS POSITION

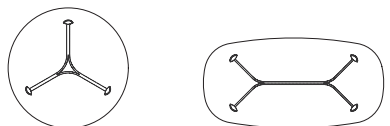

Minotti

PIANO FRASSINO ASH TOP

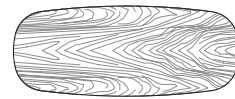
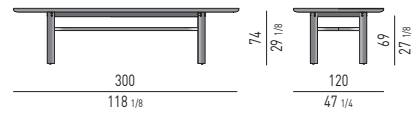
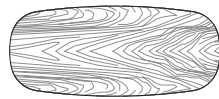
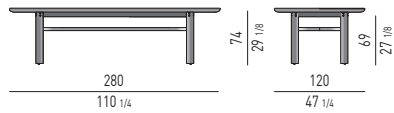
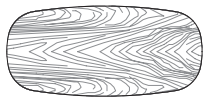
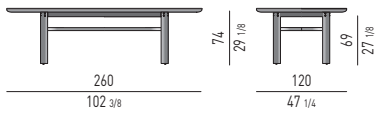
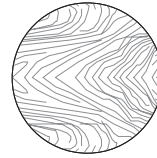
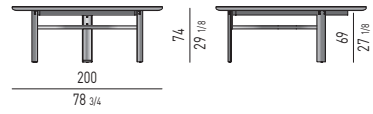
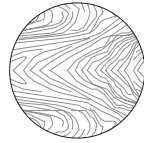
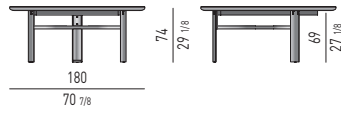
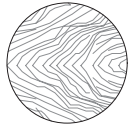
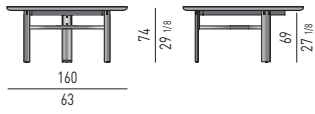

PIANO EBANO EBONY TOP

