



**Struttura:** in metallo, sottoposta a due fasi di lavorazione, sabbiatura e cataforesi. Successivamente la struttura viene annegata in schiuma di poliuretano flessibile a freddo BAYFIT® (BAYER®).

Supporti schienali e braccioli, con rinforzi in acciaio, disponibili nelle seguenti finiture:

- massello di iroko, finitura naturale, trattato con vernice protettiva ad alta resistenza ai raggi UV e agli agenti atmosferici, con un livello di brillantezza di 35 gloss;
- massello di teak (Tectona Grandis - First European Quality), finitura naturale.

Il legno viene stabilizzato in forni di essiccazione, la lavorazione del legno viene eseguita su macchine a controllo numerico con rifiniture a mano.

Sedile, schienale e braccioli rivestiti con trapuntino di fibra Solotex®, canalizzata, contenuta all'interno di una fodera idrorepellente e traspirante.

Un alamaro in alluminio verniciato color Peltro per outdoor, personalizzato con logo Minotti, permette di tenere uniti lo schienale e il bracciolo ai supporti in legno.

Un profilo in ecopelle da outdoor rifinisce il perimetro della seduta e dello schienale. Il profilo è disponibile nei seguenti colori: Sand, Grigio Chiaro, Grigio Scuro e Marrone.

**Cuscineria:** imbottitura cuscini schienale totalmente in fibra Solotex® canalizzata.

**Sfoderabilità:** completamente sfoderabile. Rivestimento schienali e braccioli sfoderabile sganciando gli alamari.

**Piedini:** in massello di iroko oppure in massello di teak, finitura naturale, con sistema di regolazione. Scivolante protettivo in SEBS colore nero (gomma morbida antigraffio).

### SCHIENALE AMOVIBILE

Imbottitura in poliuretano espanso a quote differenziate ad alta densità, successivamente rivestito con fibra termolegata traspirante accoppiata con tessuto idrorepellente.

Un profilo in ecopelle da outdoor rifinisce il perimetro dello schienale. Il profilo è disponibile nei seguenti colori: Sand, Grigio Chiaro, Grigio Scuro e Marrone.

Per migliorare l'aderenza dell'elemento amovibile alla seduta, all'interno è stato inserito un peso. Tessuto antiscivolo sul fondo. Completamente sfoderabile.

**Structure:** metal, processed in two phases - sand blasting and e-coating. Then the structure is coated in flexible, cold-formed BAYFIT® (BAYER®) polyurethane foam. Steel-reinforced backrest and armrest supports available in the following finishes:

- solid iroko, natural finish, treated with a protective coating, making it highly resistant to sunlight and weather, and with a level-35 gloss finish;
- solid teak (Tectona Grandis - First European Quality), natural finish; The wood is kiln-dried; wood is processed on CNC machines and then finished by hand.

Seat, backrests and armrests covered in lightweight, channeled quilting in Solotex® fiber, inside a breathable, water-resistant casing.

A Minotti-personalized aluminium frog fastener, varnished Pewter colour for outdoors, is used to keep the backrest and armrests fastened to the wood supports.

The seat and backrest edges are trimmed with outdoor eco-leather piping. The piping comes in the following colours: Sand, Light Grey, Dark Grey and Brown.

**Cushions:** backrests cushions padded entirely in channeled Solotex® fiber.

**Covers:** completely removable.

Backrests and armrests covers can be removed by unhooking the frogs.

**Feet:** adjustable, in solid natural iroko or in solid teak, natural finish.

Protective black-painted SEBS glide (soft scratchproof rubber).

### REMOVABLE BACKREST

Padded with high resilience, variable-density polyurethane foam and then covered with breathable, heat-bonded fiber laminated to water-repellent fabric.

The backrest edges are trimmed with outdoor eco-leather piping. The piping comes in the following colours: Sand, Light Grey, Dark Grey and Brown.

A weight was integrated into the removable element to improve adherence to the seat.

Non-slip fabric on the bottom.

Covers are completely removable.

**Struktur:** Aus in zwei Arbeitsphasen behandeltem Metall: Sandstrahl und kathodische Tauchlackierung. Danach wird die Struktur in weiches, kaltgeschäumtes Polyurethan BAYFIT® (BAYER®) eingebettet.

Stützen von Rücken- und Armlehnen, mit Verstärkung aus Stahl, erhältlich in folgenden Ausführungen:

- massives Iroko, Oberfläche nature, behandelt mit Schutzlack mit hoher Resistenz gegen UV-Strahlen und Festigkeit gegen Witterungseinflüsse, Glanzgrad 35 Gloss;
- massives Teak (Tectona Grandis - First European Quality), Oberfläche nature.

Das Holz wird im Trocknungs-Ofen stabilisiert, die Verarbeitung erfolgt auf Maschinen mit CNC-Steuerung und manueller Endbearbeitung.

Sitz, Rücken- und Armlehnen bezogen mit Steppstoff gefüllt mit Solotex®, in einem wasserabstoßenden, atmungsaktiven Überzug.

Ein zinnfarbig, spezifisch für den Außenbereich lackierter Schnürverschluss aus Aluminium, mit dem Minotti-Zeichen, verbindet Rücken- und Armlehnen mit den Holz-Stützen.

Eine Umrandung aus Kunstleder für den Außenbereich zeichnet das Profil des Sitzes und der Rückenlehne nach. Diese eingepaselte Umrandung ist in folgenden Farben erhältlich: Sand, Hellgrau, Dunkelgrau und Braun.

**Kissen:** Polsterung der Rücken- und Armlehnenkissen komplett aus kanalisierter Solotex® Faser.

**Abziehbarkeit:** vollkommen abziehbar. Rücken- und Armlehnenbezüge nach Lösung der Schnürverschlüsse abziehbar.

**Füßchen:** Aus Iroko-Massivholz oder aus Teak-Massivholz, mit naturbelassener Oberfläche, höhenverstellbar. Gleitschutz aus schwarzfarbigem SEBS (weicher, kratzfester Gummi).

### ABNEHMBARE RÜCKENLEHNE

Polsterung aus hochdichtem, unterschiedlich geschäumtem Polyurethanschaum, dann bezogen mit atmungsaktiver, thermofixierter Faser, kombiniert mit einem wasserabweisenden Stoff.

Eine Umrandung aus Kunstleder für den Außenbereich zeichnet das Profil der Rückenlehne nach. Diese eingepaselte Umrandung ist in folgenden Farben erhältlich: Sand, Hellgrau, Dunkelgrau und Braun.

Damit das abnehmbare Element besser am Sitz festsetzt, wurde ein Gewicht integriert.

Rutschfestes Gewebe am Boden des Elements.

Vollkommen abziehbar.

**Structure:** en métal, soumise à un traitement en deux étapes, sablage et cataphorèse. La structure est ensuite noyée dans de la mousse de polyuréthane souple obtenue par moulage à froid BAYFIT® (BAYER®). Supports dossiers et accoudoirs, avec renforts en acier, disponibles dans les finitions suivantes :

- iroko massif, finition naturel, traité avec un vernis protecteur haute résistance aux rayons UV et agents atmosphériques, niveau de brillance de 35 gloss ;
- teak massif (Tectona Grandis - First European Quality), finition naturel. Le bois est stabilisé dans des fours de séchage, le traitement du bois est effectué sur des machines à commande numérique avec finition à la main.

Assise, dossier et accoudoirs recouverts d'un édredon en fibre Solotex®, canalisée, contenue dans une housse hydrofuge et respirante. Un brandebourg personnalisé Minotti, en aluminium peint couleur Étain pour l'extérieur, permet d'unir le dossier et l'accoudoir aux supports en bois.

Un cordon en éco-cuir pour l'extérieur, termine le périmètre de l'assise et du dossier. Le cordon est disponible dans les coloris suivants : Sand, Gris Clair, Gris Foncé et Marron.

**Coussins :** rembourrage des coussins du dossier entièrement en fibre Solotex® canalisée.

**Déhoussage :** entièrement déhoussables. Revêtements des dossiers et accoudoirs déhoussables en désolidarisant les brandebourgs.

**Pieds :** en iroko massif ou en Teak massif, finition naturelle, avec système de réglage.

Patins glisseurs en SEBS couleur noir (caoutchouc souple anti-rayure).

### DOSSIER AMOVIBLE

Rembourrage en polyuréthane expansé à densité différenciée et haute densité, ultérieurement recouvert de fibre thermoliée respirante, associée à un tissu hydrofuge.

Un cordon en éco-cuir pour l'extérieur, termine le périmètre du dossier. Le cordon est disponible dans les coloris suivants : Sand, Gris Clair, Gris Foncé et Marron.

Pour améliorer l'adhérence de l'élément amovible à l'assise, on a inséré un poids à l'intérieur. Tissu antidérapant sur le bas.

Entièrement déhoussable

# Minotti

## TAVOLINO

**Piano:** Pietra del Cardoso, spessore 30 mm, sagomato e spazzolato a grana fine. Il piano poggia su una struttura di metallo verniciata lucida con polvere poliestere per esterno nel colore Peltro lucido. Il piano in pietra viene sottoposto ad un trattamento antimacchia, che tuttavia non ne garantisce la totale protezione.

**Gambe:** in massello di iroko oppure in massello di teak, finitura naturale, con scivolante protettivo in SEBS colore nero (gomma morbida antigraffio).

## COFFEE TABLE

**Top:** 30 mm Pietra del Cardoso stone, contoured and fine-grain brushed. The top rests on a metal structure with polished polyester powder-coat exterior finish in Pewter colour.

The top is then given a stain-resistant treatment which does not, however, guarantee total stain protection.

**Legs:** in solid natural iroko or in solid teak, natural finish, with black protective SEBS (soft scratchproof rubber) glides.

## BEISTELLTISCH

**Tischplatte:** aus dem Naturstein Pietra del Cardoso, Stärke 30 mm, formgeschnitten und feinkörnig gebürstet. Die Platte liegt auf einer Metallstruktur auf, die mit Polyester für den Außenbereich glänzend zinnfarbig pulverlackiert ist.

Der Stein wird mit einem Fleckenschutz imprägniert, der aber keine volle Versiegelung garantiert.

**Beine:** Aus Iroko-Massivholz oder aus Teak-Massivholz, mit naturbelassener Oberfläche, mit Schutzgleiter aus SEBS in Schwarz (weiches, kratzfestes Gummi).

## PETITE TABLE

**Plateau:** en Pietra del Cardoso, épaisseur 30 mm, façonnée et brossée grain fin. Le plateau repose sur une structure en métal, peinture brillante poudre polyester pour extérieur couleur Étain.

Le plateau en pierre est sujet au traitement anti-tache, qui toutefois ne garantit pas une protection totale.

**Pieds:** en iroko massif ou en Teck massif, finition naturelle, avec patins glisseurs en SEBS noir (caoutchouc souple anti-rayures).

## TAVOLINO COFFEE TABLE

### PIANO TOP

### PIETRA STONE



### GAMBE LEGS

### LEGNO WOOD

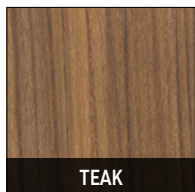
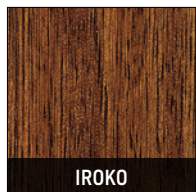

### ALAMARI FROGS

### ALLUMINIO ALUMINIUM



## SUPPORTI E PIEDINI SUPPORTS AND FEET

### LEGNO WOOD

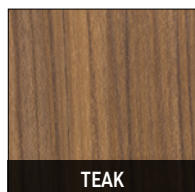
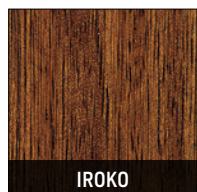

## PROFILI PIPING

### ECOPELLE DA OUTDOOR OUTDOOR ECO-LEATHER

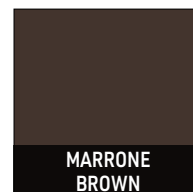

# Minotti

## DIVANO | SOFA

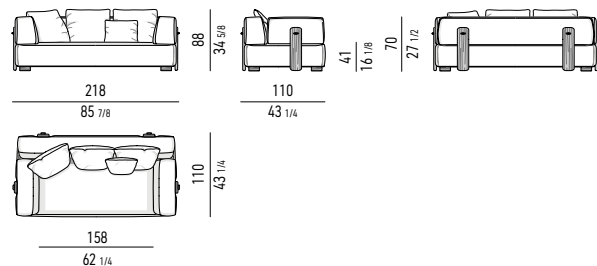

## ELEMENTI TERMINALI | ELEMENTS WITH 1 ARMREST

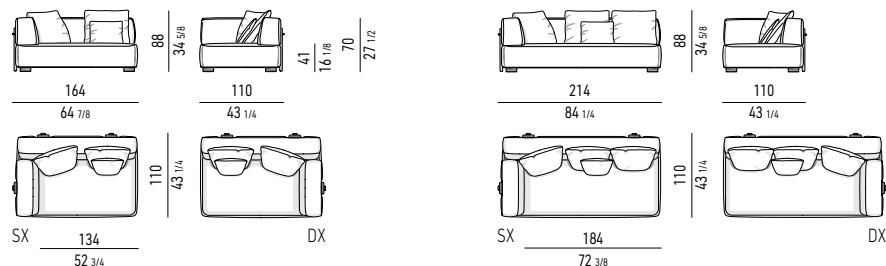

## ELEMENTI CENTRALI | CENTRAL ELEMENTS

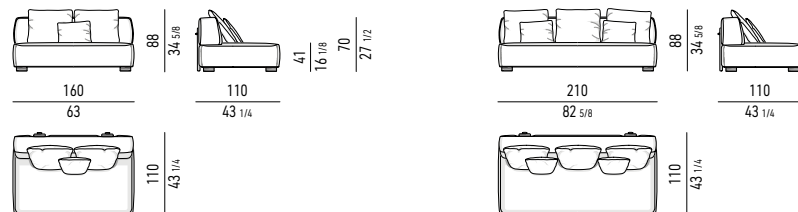

## ELEMENTO TERMINALE PENISOLA | OPEN-END ELEMENT WITH 1 ARMREST

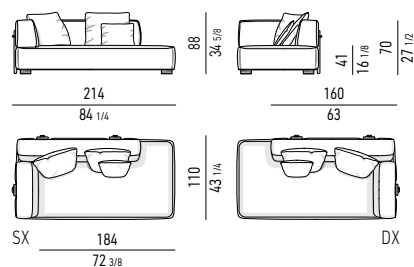

## COUCH | COUCHES

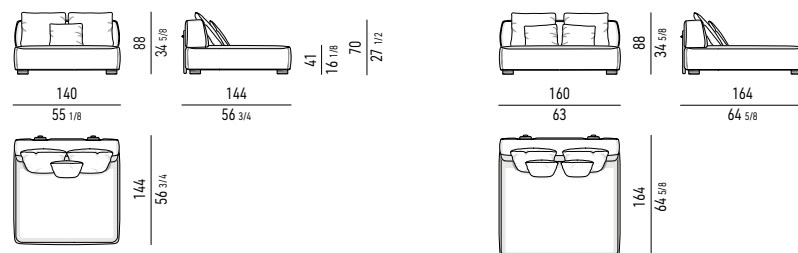

## LOVESEAT

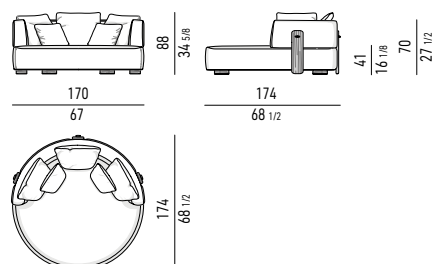

# Minotti

## ANGOLO CURVO | ROUND CORNER

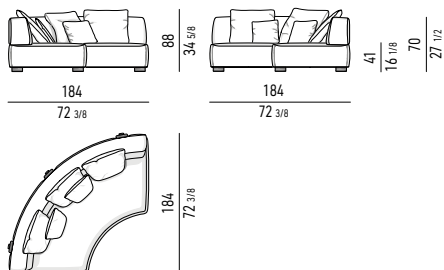

## ANGOLO CURVO PENISOLA | ROUND OPEN-END CORNER

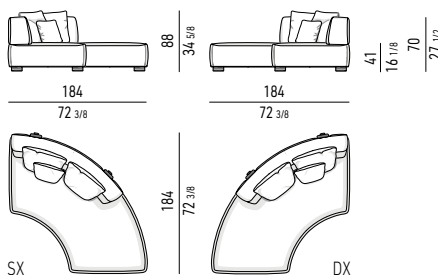

## POUF | OTTOMANS

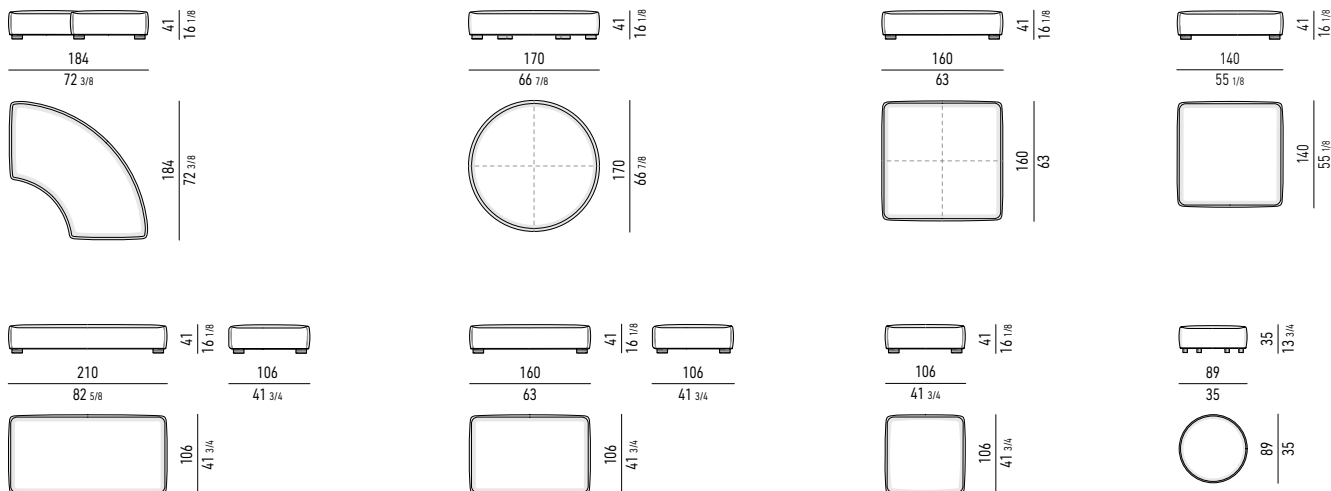

## SCHIENALE AMOVIBILE | REMOVABLE BACKREST

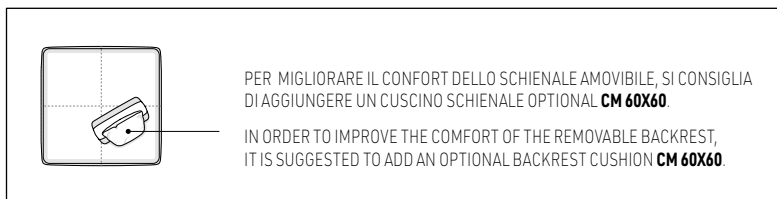
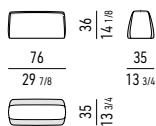

## CUSCINO SCHIENALE OPTIONAL | OPTIONAL BACKREST CUSHION

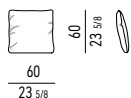

## CUSCINO OPTIONAL | OPTIONAL CUSHION

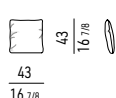

## TAVOLINO | COFFEE TABLE

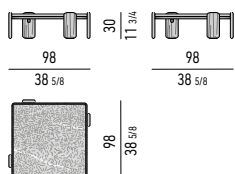

## OPTIONAL RAIN COVER

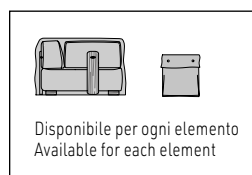

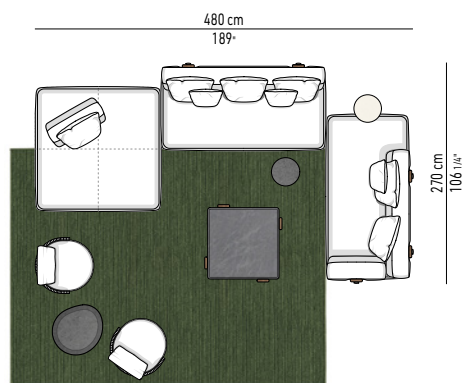

- A**
- 1 Florida - pouf cm 160x160 H41
  - 1 Florida - schienale amovibile cm 76x35 H36
  - 1 Florida - cuscino schienale optional cm 60x60
  - 1 Florida - elemento centrale cm 210x110 H88
  - 1 Florida - elemento terminale penisola dx cm 214x110 H88
  - 1 Florida - tavolino cm 98x98 H30
  - 2 Torii Nest Outdoor - poltrone con base girevole cm 71x76 H80
  - 1 Stony - tavolino cm 67,5x60 H40
  - 1 Cesar Outdoor - tavolino/pouf mod. B Ø cm 36 H45
  - 1 Warren Outdoor - tavolino Ø cm 35 H55
  - 1 Avery - tappeto cm 400x300
- 1 Florida - ottoman cm 160x160 H41
  - 1 Florida - removable backrest cm 76x35 H36
  - 1 Florida - optional backrest cushion cm 60x60
  - 1 Florida - central element cm 210x110 H88
  - 1 Florida - open-end element with armrest dx cm 214x110 H88
  - 1 Florida - coffee table cm 98x98 H30
  - 2 Torii Nest Outdoor - armchairs with swivel base cm 71x76 H80
  - 1 Stony - coffee table cm 67,5x60 H40
  - 1 Cesar Outdoor - coffee table/stool mod. B Ø cm 36 H45
  - 1 Warren Outdoor - side table Ø cm 35 H55
  - 1 Avery - rug cm 400x300
- 1 Florida - Hocker cm 160x160 H41
  - 1 Florida - abnehmbare Rückenlehne cm 76x35 H36
  - 1 Florida - Rückenkissen fakultativ cm 60x60
  - 1 Florida - Mittelelement cm 210x110 H88
  - 1 Florida - Halbinsenelement mit Armlehne dx cm 214x110 H88
  - 1 Florida - Beistelltisch cm 98x98 H30
  - 2 Torii Nest Outdoor - Sessel mit drehbar Basis cm 71x76 H80
  - 1 Stony - Beistelltisch cm 67,5x60 H40
  - 1 Cesar Outdoor - Beistelltisch/Hocker mod. B Ø cm 36 H45
  - 1 Warren Outdoor - Beistelltisch Ø cm 35 H55
  - 1 Avery - Teppich cm 400x300

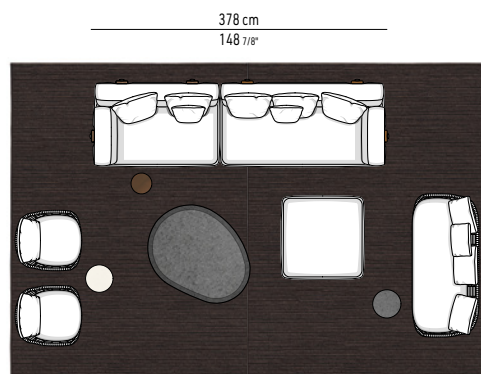

- B**
- 1 Florida - elemento terminale sx cm 164x110 H88
  - 1 Florida - elemento terminale dx cm 214x110 H88
  - 1 Florida - pouf cm 106x106 H41
  - 2 Belt Cord Outdoor - poltrone cm 77x86 H80
  - 1 Belt Cord Outdoor - divano cm 182x85 H85
  - 1 Warren Outdoor - tavolino Ø cm 35 H55
  - 1 Pilotis Outdoor - tavolino Ø cm 27 H55
  - 1 Stony - tavolino cm 140x109 H28
  - 1 Cesar Outdoor - tavolino/pouf mod. B Ø cm 36 H45
  - 2 Avery - tappeti cm 400x300
- 1 Florida - element with 1 armrest sx cm 164x110 H88
  - 1 Florida - element with 1 armrest dx cm 214x110 H88
  - 1 Florida - ottoman cm 106x106 H41
  - 2 Belt Cord Outdoor - armchairs cm 77x86 H80
  - 1 Belt Cord Outdoor - sofa cm 182x85 H85
  - 1 Warren Outdoor - side table Ø cm 35 H55
  - 1 Pilotis Outdoor - side table Ø cm 27 H55
  - 1 Stony - side table cm 140x109 H28
  - 1 Cesar Outdoor - coffee table/stool mod. B Ø cm 36 H45
  - 2 Avery - rugs cm 400x300
- 1 Florida - Endelement mit 1 Armlehne sx cm 164x110 H88
  - 1 Florida - Endelement mit 1 Armlehne dx cm 214x110 H88
  - 1 Florida - Hocker cm 106x106 H41
  - 2 Belt Cord Outdoor - Sessel cm 77x86 H80
  - 1 Belt Cord Outdoor - Sofa cm 182x85 H85
  - 1 Warren Outdoor - Beistelltisch Ø cm 35 H55
  - 1 Pilotis Outdoor - Beistelltisch Ø cm 27 H55
  - 1 Stony - Beistelltisch cm 140x109 H28
  - 1 Cesar Outdoor - Beistelltisch/Hocker mod. B Ø cm 36 H45
  - 2 Avery - Teppiche cm 400x300

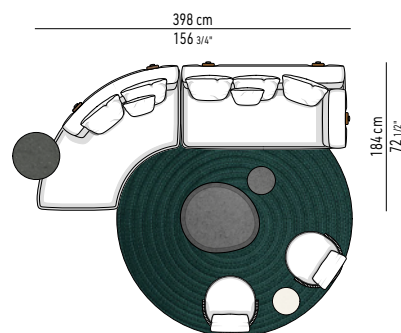

- C**
- 1 Florida - angolo curvo penisola dx cm 184x184 H88
  - 1 Florida - elemento terminale dx cm 214x110 H88
  - 2 Torii Nest Outdoor - poltrone con base girevole cm 71x76 H80
  - 1 Bellagio Outdoor - tavolino Ø cm 60 H52
  - 1 Stony - tavolino cm 101x90 H28
  - 1 Cesar Outdoor - tavolino/pouf mod. A Ø cm 36 H45
  - 1 Warren Outdoor - tavolino Ø cm 35 H55
  - 1 Avery - tappeto Ø cm 300
- 1 Florida - round open-end corner dx cm 184x184 H88
  - 1 Florida - element with 1 armrest dx cm 214x110 H88
  - 2 Torii Nest Outdoor - armchairs with swivel base cm 71x76 H80
  - 1 Bellagio Outdoor - side table Ø cm 60 H52
  - 1 Stony - coffee table cm 101x90 H28
  - 1 Cesar Outdoor - coffee table/stool mod. A Ø cm 36 H45
  - 1 Warren Outdoor - side table Ø cm 35 H55
  - 1 Avery - rug Ø cm 300
- 1 Florida - rundes Halbinsel Eckelement dx cm 184x184 H88
  - 1 Florida - Endelement mit 1 Armlehne dx cm 214x110 H88
  - 2 Torii Nest Outdoor - Sessel mit drehbar Basis cm 71x76 H80
  - 1 Bellagio Outdoor - Beistelltisch Ø cm 60 H52
  - 1 Stony - Beistelltisch cm 101x90 H28
  - 1 Cesar Outdoor - Beistelltisch/Hocker mod. A Ø cm 36 H45
  - 1 Warren Outdoor - Beistelltisch Ø cm 35 H55
  - 1 Avery - Teppich Ø cm 300

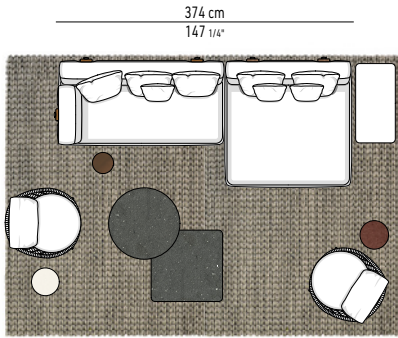

- D**
- 1 Florida - elemento terminale sx cm 214x110 H88
  - 1 Florida - couch cm 160x164 H88
  - 2 Lido Cord Outdoor - poltrone cm 88x95 H82
  - 1 Warren Outdoor - tavolino Ø cm 35 H55
  - 1 Pilotis Outdoor - tavolino Ø cm 27 H55
  - 1 Lido Outdoor - tavolino Ø cm 90 H35
  - 1 Lido Outdoor - tavolino cm 90x90 H22
  - 1 Cesar Outdoor - tavolino mod. A Ø cm 36 H45
  - 1 Block Outdoor - tavolino cm 100x50 H40
  - 2 Jersey - tappeti cm 350x250
- 1 Florida - elemento con 1 armrest sx cm 214x110 H88
  - 1 Florida - couch cm 160x164 H88
  - 2 Lido Cord Outdoor - armchairs cm 88x95 H82
  - 1 Warren Outdoor - side table Ø cm 35 H55
  - 1 Pilotis Outdoor - side table Ø cm 27 H55
  - 1 Lido Outdoor - coffee table Ø cm 90 H35
  - 1 Lido Outdoor - coffee table cm 90x90 H22
  - 1 Cesar Outdoor - side table mod. A Ø cm 36 H45
  - 1 Block Outdoor - side table cm 100x50 H40
  - 2 Jersey - rugs cm 350x250
- 1 Florida - Endelement mit 1 Armlehne sx cm 214x110 H88
  - 1 Florida - Couch cm 160x164 H88
  - 2 Lido Cord Outdoor - Sessel cm 88x95 H82
  - 1 Warren Outdoor - Beistelltisch Ø cm 35 H55
  - 1 Pilotis Outdoor - Beistelltisch Ø cm 27 H55
  - 1 Lido Outdoor - Beistelltisch Ø cm 90 H35
  - 1 Lido Outdoor - Beistelltisch cm 90x90 H22
  - 1 Cesar Outdoor - Beistelltisch mod. A Ø cm 36 H45
  - 1 Block Outdoor - Beistelltisch cm 100x50 H40
  - 2 Jersey - Teppiche cm 350x250

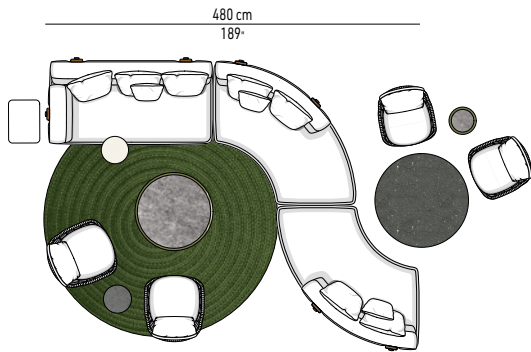

- E**
- 1 Florida - elemento terminale sx cm 214x110 H88
  - 2 Florida - angoli curvi penisola sx cm 184x184 H88
  - 2 Belt Cord Outdoor - poltrone cm 77x86 H80
  - 2 Belt Cord Outdoor - poltrone Lounge cm 71x75 H82
  - 1 Block Outdoor - tavolino cm 55x40 H45
  - 1 Warren Outdoor - tavolino Ø cm 35 H55
  - 1 Cesar Outdoor - tavolino/pouf mod. B Ø cm 36 H45
  - 1 Caulfield Outdoor - tavolino Ø cm 100 H28,5
  - 1 Bellagio Outdoor - tavolo Lounge Dining Ø cm 120 H67
  - 1 Caulfield Outdoor - tavolino Ø cm 35 H45,5
  - 1 Avery - tappeto Ø cm 300
- 1 Florida - elemento con 1 armrest sx cm 214x110 H88
  - 2 Florida - round open-end corners sx cm 184x184 H88
  - 2 Belt Cord Outdoor - armchairs cm 77x86 H80
  - 2 Belt Cord Outdoor - Lounge armchairs cm 71x75 H82
  - 1 Block Outdoor - side table cm 55x40 H45
  - 1 Warren Outdoor - side table Ø cm 35 H55
  - 1 Cesar Outdoor - coffee table/stool mod. B Ø cm 36 H45
  - 1 Caulfield Outdoor - coffee table Ø cm 100 H28,5
  - 1 Bellagio Outdoor - Lounge Dining table Ø cm 120 H67
  - 1 Caulfield Outdoor - side table Ø cm 35 H45,5
  - 1 Avery - rug Ø cm 300
- 1 Florida - Endelement mit 1 Armlehne sx cm 214x110 H88
  - 2 Florida - rundes Halbinsel Eckelemente sx cm 184x184 H88
  - 2 Belt Cord Outdoor - Sessel cm 77x86 H80
  - 2 Belt Cord Outdoor - Lounge Sessel cm 71x75 H82
  - 1 Block Outdoor - Beistelltisch cm 55x40 H45
  - 1 Warren Outdoor - Beistelltisch Ø cm 35 H55
  - 1 Cesar Outdoor - Beistelltisch/Hocker mod. B Ø cm 36 H45
  - 1 Caulfield Outdoor - Beistelltisch Ø cm 100 H28,5
  - 1 Bellagio Outdoor - Lounge Dining Tisch Ø cm 120 H67
  - 1 Caulfield Outdoor - Beistelltisch Ø cm 35 H45,5
  - 1 Avery - Teppich Ø cm 300

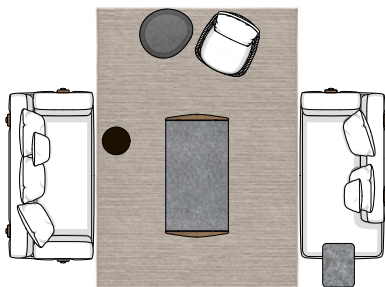

- F**
- 1 Florida - divano cm 218x110 H88
  - 1 Florida - elemento terminale penisola sx cm 214x110 H88
  - 1 Belt Cord Outdoor - poltrona Lounge cm 71x75 H82
  - 1 Warren Outdoor - tavolino Ø cm 35 H55
  - 1 Stony - tavolino cm 67,5x60 H40
  - 1 Fynn Outdoor - tavolino cm 155x80 H28
  - 1 Block Outdoor - tavolino cm 55x40 H45
  - 1 Avery - tappeto cm 350x250
- 1 Florida - sofa cm 218x110 H88
  - 1 Florida - open-end element with 1 armrest sx cm 214x110 H88
  - 1 Belt Cord Outdoor - Lounge armchair cm 71x75 H82
  - 1 Warren Outdoor - side table Ø cm 35 H55
  - 1 Stony - side table cm 67,5x60 H40
  - 1 Fynn Outdoor - coffee table cm 155x80 H28
  - 1 Block Outdoor - side table cm 55x40 H45
  - 1 Avery - rug cm 350x250
- 1 Florida - sofa cm 218x110 H88
  - 1 Florida - Halbinselement mit 1 Armlehne sx cm 214x110 H88
  - 1 Belt Cord Outdoor - Lounge Sessel cm 71x75 H82
  - 1 Warren Outdoor - Beistelltisch Ø cm 35 H55
  - 1 Stony - Beistelltisch cm 67,5x60 H40
  - 1 Fynn Outdoor - Beistelltisch cm 155x80 H28
  - 1 Block Outdoor - Beistelltisch cm 55x40 H45
  - 1 Avery - Teppich cm 350x250