

ALLEN

DESIGN RODOLFO DORDONI



Struttura: in legno multistrato con molleggio garantito da cinghie elastiche ad alta componente di caucciù. Traversi di rinforzo in metallo. Preparazione della struttura in poliuretano espanso a quote differenziate ad alta densità.

Imbottitura bracciolo e schienale realizzata con inserto schiumato ignifugo con quota morbida per conferire comfort e sofficià.

Ulteriore rivestimento in fibra termolegata di forte spessore ed accoppiata con tela di cotone bianca.

Cuscinitura: imbottitura cuscino seduta in piuma d'oca canalizzata con inserto centrale in poliuretano espanso ad alta resilienza.

Cuscini schienale totalmente imbottiti in piuma d'oca canalizzata.

Sfoderabilità: rivestimento sfoderabile solo in tessuto. Rivestimento in pelle fisso solo per la struttura, cuscini schienale e seduta sfoderabili.

Piedini: appoggio a terra tramite piedini stampati in alluminio pressofuso verniciato color Peltro, con finitura lucida anti-touch.

Scivolante protettivo in Hytrel® (gomma morbida antigraffio).

Frame: plywood frame with seating suspension guaranteed by elastic straps with a high rubber content. Metal reinforcements set crosswise. Frame let into high-density polyurethane foam in different densities.

Armrest and backrest padding with soft fireproof foam insert for enhanced softness and comfort.

Additional thick fiber lining thermally bound to a white canvas.

Cushions: channeled goose down filling for the seat cushions with very resilient polyurethane foam central insert.

Channeled goose down for the backrest cushions.

Cover: fully removable fabric covers. Unremovable leather for the frame, removable leather backrest and seat cushion covers.

Feet: molded die-cast aluminium feet, Pewter colour varnished with polished anti-touch finish.

Protective Hytrel® glide (soft scratchproof rubber).

Struktur: aus Schichtholz, Federung garantiert mit elastischen Riemen mit hohem Kautschukanteil. Metallquerstreben. Strukturbeschichtung mit unterschiedlich dick geschäumtem, hochdichtem Polyurethan.

Arm- und Rückenlehne mit feuerfester, besonders weicher Schaumeinlage, die Komfort und Schmiegsamkeit garantiert. Weitere Beschichtung mit extradicker, wärmesensibler Faser kombiniert mit weißem Baumwolltuch.

Kissen: Sitzkissen mit kanalisierter Daunenfüllung mit zentraler Einlage aus hochelastischem PU-Schaum.

Kissen der Rückenlehne mit kanalisiert belüfteter Daunenfüllung.

Abziehbarkeit: Nur der Stoffbezug ist abziehbar. Fester Lederbezug nur am Gestell, Sitz- und Rückenkissen sind abziehbar.

FüÙe: aus Aluminiumpressguss, Zinnfarben glänzlackiert mit Anti-Fingerprint-Beschichtung.

Gleitschutz durch Hytrel® (weicher, kratzfester Gummi).

Structure : en bois contreplaqué, suspension garantie par des courroies élastiques à teneur élevée en caoutchouc. Traverses de renfort en métal. Préparation de la structure en polyuréthane expansé à hauteurs différenciées et haute densité.

Rembourrage des accoudoirs et du dossier réalisé avec un insert en mousse ignifuge à hauteur souple pour donner confort et moelleux.

Ulterieur revêtement en fibre thermoliée de forte épaisseur et couplé à de la toile de coton blanche.

Coussins : rembourrage du coussin de l'assise en plume d'oie canalisée, avec insert central en polyuréthane expansé à haute résilience.

Coussins du dossier entièrement rembourrés en plume d'oie canalisée.

Déhoussage : seul le revêtement en tissu est déhoussable. Le revêtement en cuir de la structure est fixe, celui de coussins, dossier et assise est déhoussable.

Pieds : pieds d'appui au sol estampés en aluminium moulé sous pression et laquées couleur Étain, finition brillant anti-trace.

Patin de protection en Hytrel® (gomme souple anti-rayure).

FINITURA PIEDINI FEET FINISH

ALLUMINIO ALUMINIUM

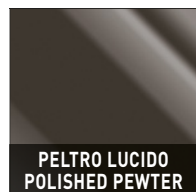

PELTRO LUCIDO
POLISHED PEWTER

DIVANO | SOFA

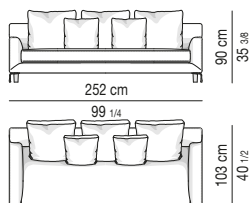
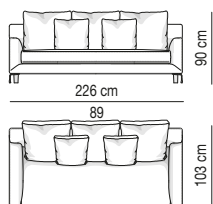
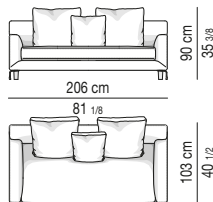
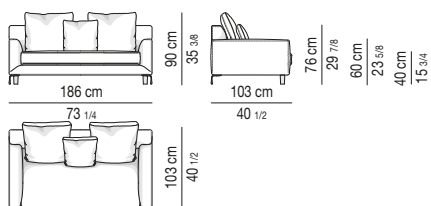

DIVANO COMPOSTO | TWO ELEMENTS SOFA

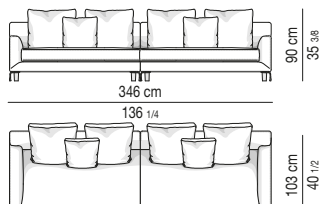
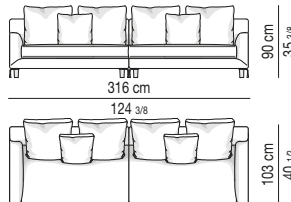
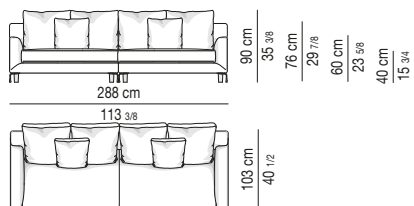

ELEMENTO CENTRALE | CENTRAL ELEMENT

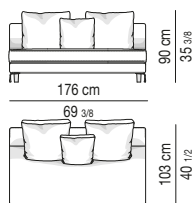
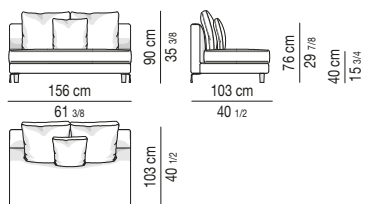

ELEMENTO TERMINALE | ELEMENT WITH 1 ARM

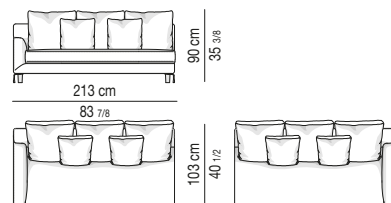
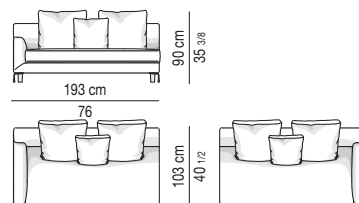
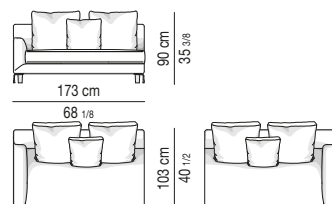
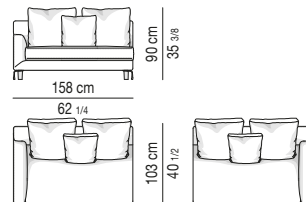
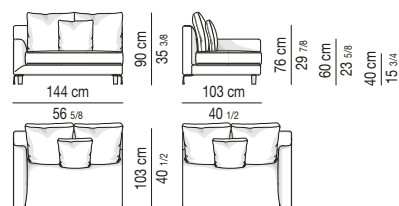

Minotti

CHAISE LONGUE

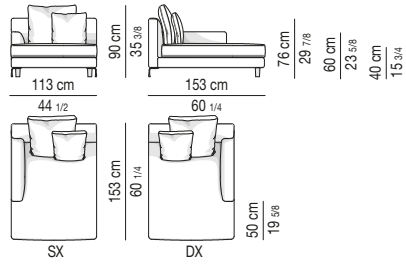

DIVANO CHAISE LONGUE | SOFA-CHAISE LONGUE

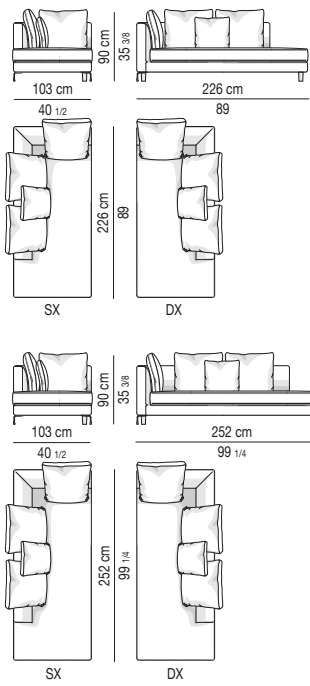

DIVANO-CHAISE LONGUE TERMINALE SOFA-CHAISE LONGUE WITH 1 ARM

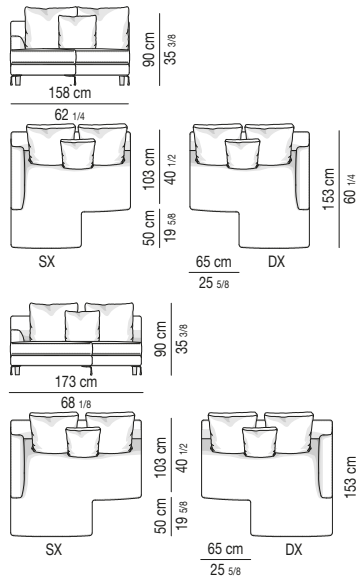
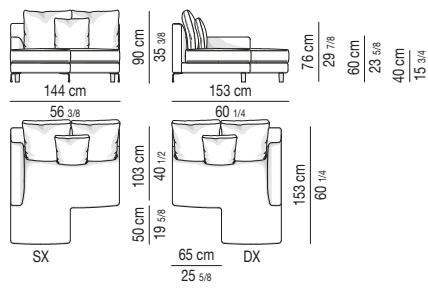

Minotti

DIVANO ANGOLARE | CORNER SOFA

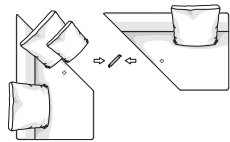
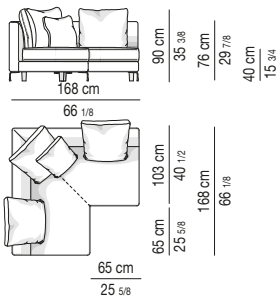

IL DIVANO ANGOLARE CM 168X168 È COMPOSTO DA 2 ELEMENTI UNITI TRA LORO TRAMITE UN SISTEMA DI AGGANCIO.

THE CORNER SOFA CM 168X168 IS COMPOSED OF 2 ELEMENTS CONNECTED THROUGH LINKING DEVICE.

DIVANO ANGOLARE CON PENISOLA CORNER SOFA WITH OPEN ELEMENT

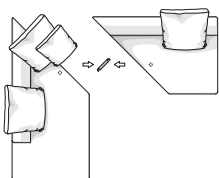
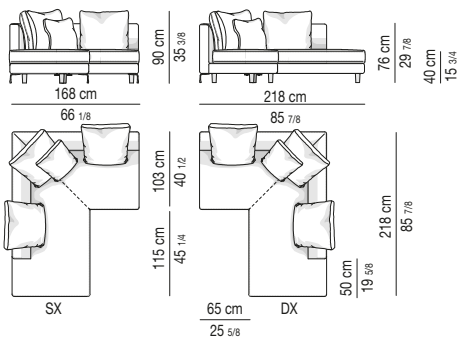

IL DIVANO ANGOLARE CON PENISOLA CM 168X218 È COMPOSTO DA 2 ELEMENTI UNITI TRA LORO TRAMITE UN SISTEMA DI AGGANCIO.

THE CORNER SOFA WITH OPEN ELEMENT CM 168X218 IS COMPOSED OF 2 ELEMENTS CONNECTED THROUGH LINKING DEVICE.

SOFA PENISOLA SENZA BRACCIOLO OPEN-END SOFA WITHOUT ARMREST

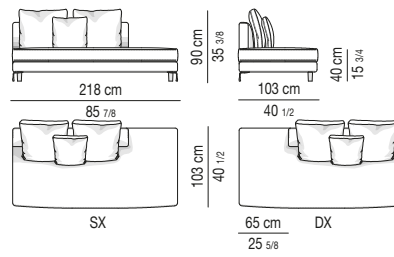

SOFA PENISOLA CON BRACCIOLO OPEN-END SOFA WITH ARMREST

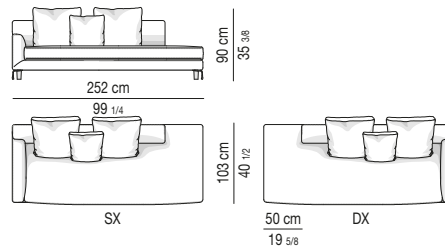
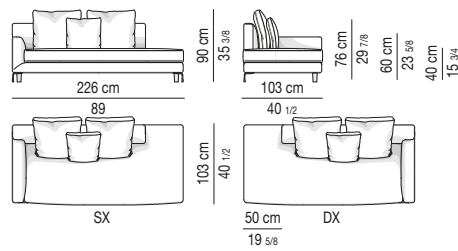

POUF | STOOL

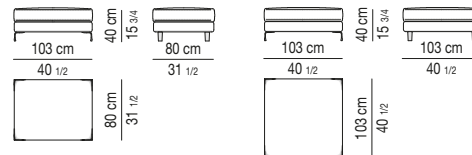

CUSCINO OPTIONAL | OPTIONAL CUSHION

