

## HARVEY LINE

DESIGN RODOLFO DORDONI



**Struttura:** mobili realizzati con struttura in legno spessore 20 mm, top assemblato a 45° alle spalle laterali.

**Ante:** in legno, spessore 30 mm con maniglia incassata in metallo, finitura Black-Nickel. Ripiano in vetro Grigio Fumè 10 mm, posto all'interno dei moduli ad ante.

**Cassetti:** con guide Blum Motion, finitura interna rovere laccato Moka a poro aperto e maniglia in metallo, finitura Black-Nickel.

**Base:** appoggio a terra tramite base in metallo da 10x50 mm laccata semilucida color Peltro (tonalità ideata da Minotti Studio) e piedini tecnici regolabili.

**Finiture:** laccato lucido nei colori Bianco, Sand, Fango, Moka, Petrolio, Grigio Stone o Granito oppure in rovere laccato Moka a poro aperto. Finitura interna laccata opaco in tinta con quella esterna.

### HARVEY HI-FI H53

Il modulo HI-FI è composto da:

- 1 vano porta lettore DVD-CD (misura interna cm 90x45 H14);
- 1 ampio cassetto (misura interna cm 86x37 H12);
- 1 contenitore con 3 scomparti (misura interna cm 27x37 H6).

L'ampio cassetto e il contenitore scorrono su guide a estrazione totale con chiusura Blum Motion.

**Structure:** cabinets with wood frame 20 mm in thickness; tops assembled at an angle of 45 degrees to the side panels.

**Doors:** wood doors 30 mm in thickness, with built-in metal handles; Black-Nickel finish. Smoked Grey glass shelf, 10 mm in thickness, for modules with doors.

**Drawers:** with Blum Motion guides; interior open-pore Moka lacquered oak finish; metal handles, Black-Nickel finish.

**Base:** metal base, 10x50 mm, lacquered in semiglossy Pewter color (shade devised by Minotti Studio); adjustable technical feet.

**Finishes:** glossy lacquered in White, Sand, Mud, Moka, Petroleum, Stone Grey or Granite and colors or finished in open-pore Moka lacquered oak. Internal finish matt lacquered matching the external finish.

### HARVEY HI-FI H53

The HI-FI module is composed of the following:

- 1 DVD-CD player compartment (interior dimensions: cm 90x45 H14);
- 1 large drawer (internal dimensions: cm 86x37 H12);
- 1 three-compartment cabinet (internal dimensions: cm 27x37 H6).

The large drawer and the cabinet are mounted on full extraction guides with Blum Motion closure.

**Gestell:** Möbel mit einem 20 mm dickem Holzgestell, 45°-Montage des Ablageelements an den Seitenwänden.

**Türen:** Holzflügel, Dicke 30 mm mit eingelassenem Metallgriff, Black-Nickel-Finish. Einlagenboden in den Flügelmodulen aus 10 mm Rauchglas.

**Schubladen:** mit Blum Motion Führungen, Innenfinish aus Eiche, offenporig lackiert in Mokka, und Metallgriff im Black-Nickel-Finish.

**Grundgestell:** Die Auflage auf dem Boden erfolgt durch ein 10x50 mm starkes Metallgestell mit zinnfarben-em Halbglanz-Lack-Finish und technische (von Minotti Studio erfundener Farbton), höhenverstellbare Füße.

**Ausführungen:** Glanzlackierung in den Farben Weiß, Sand, Schlamm, Mokka, Petroleum, Steingrau oder Granit aus offenporig in Mokka lackiertem Eichenfurnier. Innen matt lackiert und passend zum Außenfinish.

### HARVEY HI-FI H53

Das HI-FI Modul besteht aus:

- 1 Fach für den DVD-CD-Player (Innenabmessung cm 90x45 H14);
- 1 große Schublade (Innenabmessung cm 86x37 H12);
- 1 Schrankelement mit drei Fächern (Innenabmessung cm 27x37 H6).

Die große Schublade und das Schrankelement gleiten auf komplett herausziehbaren Führungen mit Blum Motion Verschluss.

**Structure :** meubles réalisés avec structure en bois de 20 mm d'épaisseur, plateau assemblé à 45° aux épaulements latéraux.

**Portes :** en bois, épaisseur 30 mm avec poignée encastrée en métal, finition Black-Nickel. Tablette en verre Gris Fumè 10 mm, située à l'intérieur des modules à portes.

**Tiroirs :** avec glissières Blum Motion, finition interne rovere laqué Moka à pore ouvert et poignée en métal, finition Black-Nickel.

**Base :** piètement avec base en métal 10x50 mm laquée semi-brillante couleur Étain (tonalité conçue par Minotti Studio) et pieds techniques réglables.

**Finitions :** laquées brillantes, couleurs Blanc, Sand, Boue, Moka, Pétrole, Gris Stone ou Granit ou bien en chêne laqué Moka à pore ouvert. Finition interne laquée mate en teinte avec finition externe.

### HARVEY HI-FI H53

Le module HI-FI comprend :

- 1 emplacement porte-lecteur DVD-CD (mesure interne cm 90x45 H14) ;
- 1 grand tiroir (mesure interne cm 86x37 H12) ;
- 1 rangement à 3 compartiments (mesure interne cm 27x37 H6).

Le grand tiroir et le rangement coulisent sur des glissières à extraction totale et sont munis de fermeture Blum Motion.

## FINITURE STRUTTURA, ANTE E CASSETTI STRUCTURE, DOORS AND DRAWERS FINISHES

### LACCATO LUCIDO | GLOSSY LACQUERED

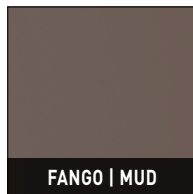
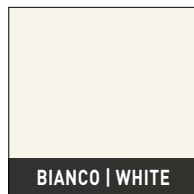

### ROVERE | OAK

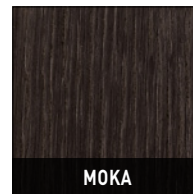

## FINITURA BASE BASE FINISH

### METALLO | METAL

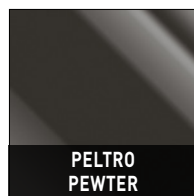

## FINITURA MANIGLIA HANDLE FINISH

### METALLO | METAL

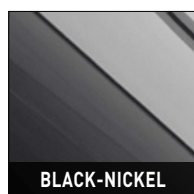

## HARVEY LINE H53

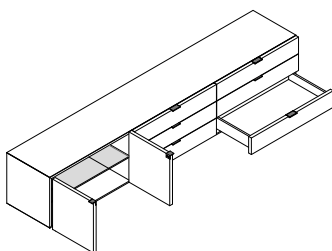
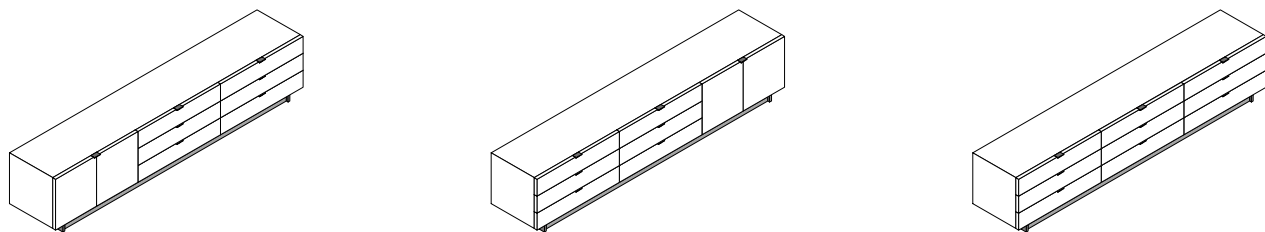
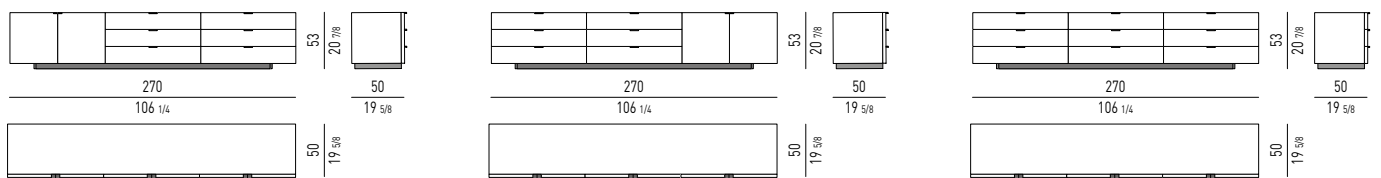
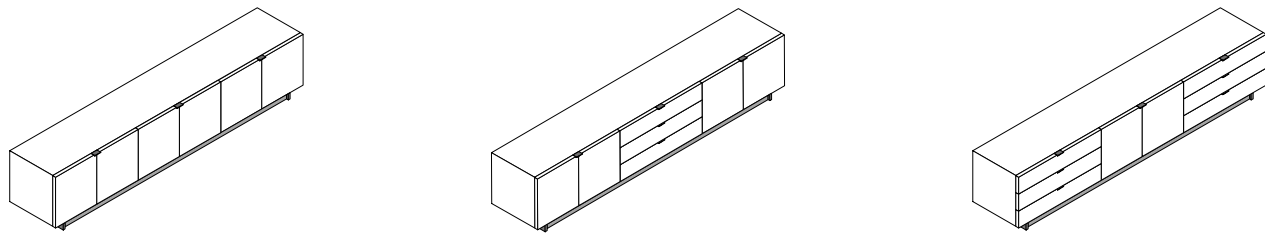
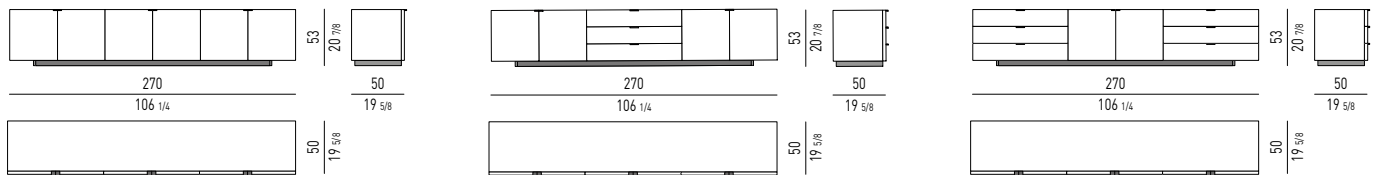
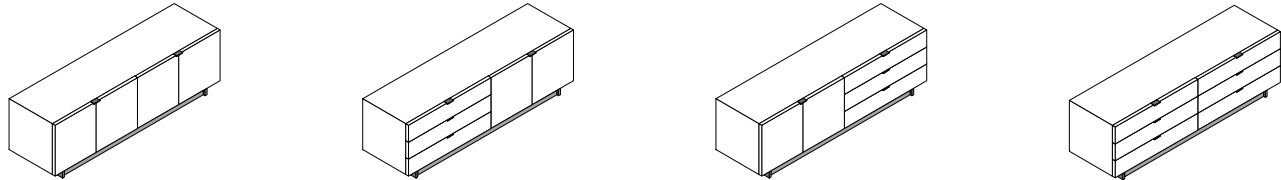
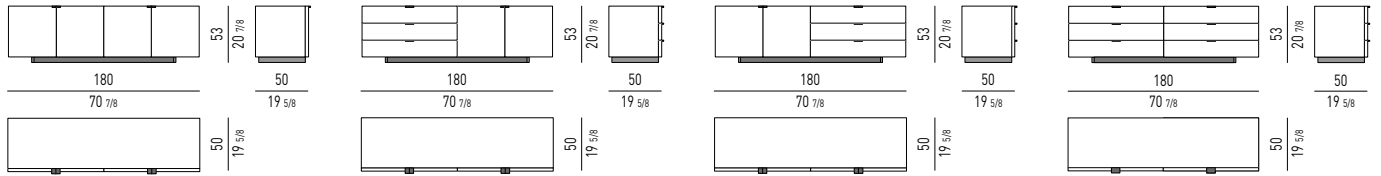

### ATTREZZATURA INTERNA CONTENITORE CON ANTE

- n. 1 ripiano in vetro fumè, spessore 10 mm, regolabile in altezza di +/- 3,2 cm.

### INTERIOR ACCESSORIES, UNIT WITH DOORS

- n. 1 shelf in smoked grey glass, 10 mm thick, height adjustable by +/- 3,2 cm.

## HARVEY LINE H74

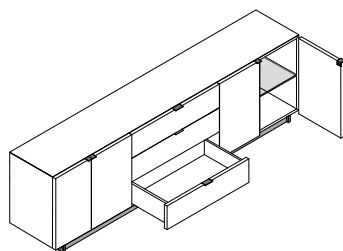
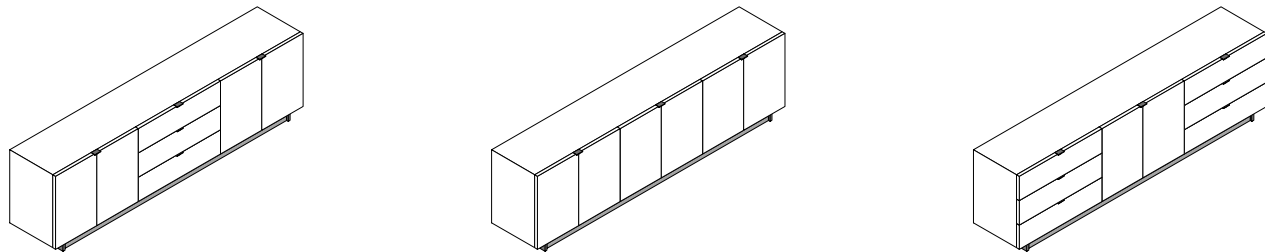
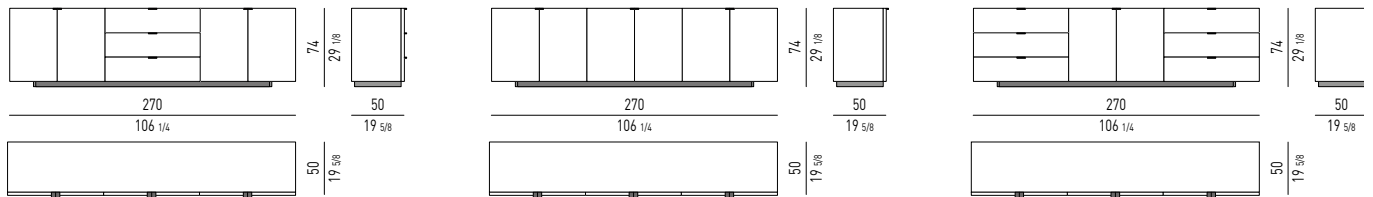
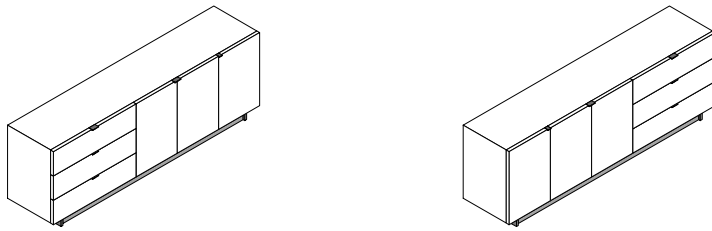
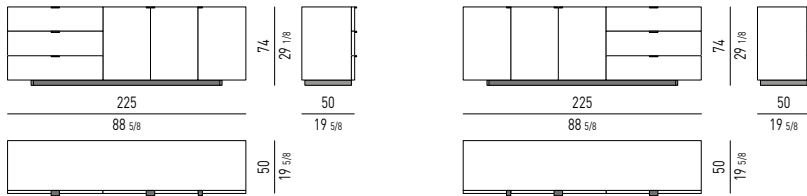
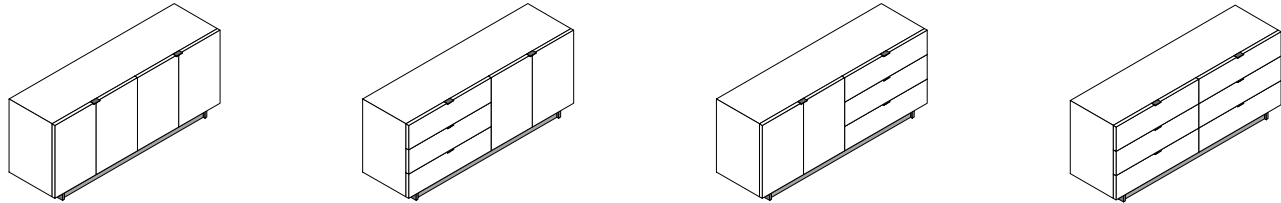
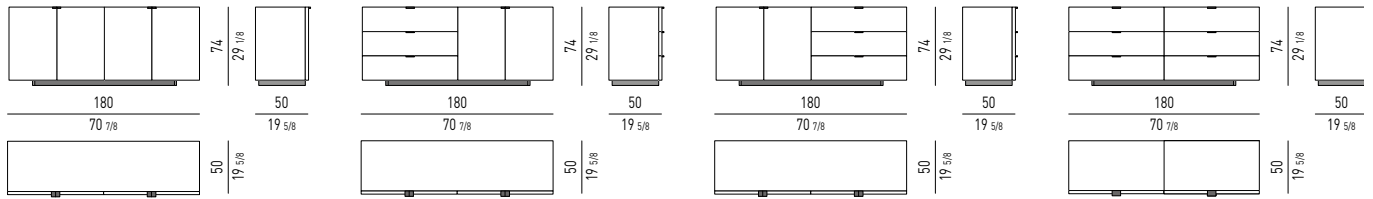

### ATTREZZATURA INTERNA CONTENITORE CON ANTE

- n. 1 ripiano in vetro fumé, spessore 10 mm, regolabile in altezza di +/- 3,2 cm.

### INTERIOR ACCESSORIES, UNIT WITH DOORS

- n. 1 shelf in smoked grey glass, 10 mm thick, height adjustable by +/- 3,2 cm.

## HARVEY LINE H101

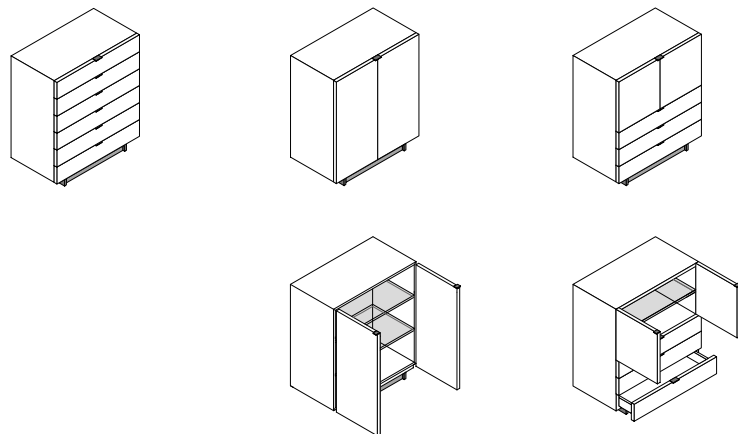
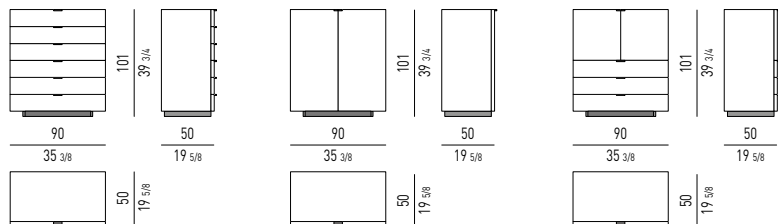

### ATTREZZATURA INTERNA

#### CONTENITORE CON ANTE

- n. 2 ripiani in vetro fumé, spessore 10 mm, regolabili in altezza di +/- 3,2 cm.

#### CONTENITORE CON ANTE E CASSETTI

- n. 1 ripiano in vetro fumé, spessore 10 mm, regolabile in altezza di +/- 3,2 cm

### INTERIOR ACCESSORIES

#### UNIT WITH DOORS

- n. 2 shelves in smoked grey glass, 10 mm thick, height adjustable by +/- 3,2 cm.

#### UNIT WITH DOORS AND DRAWERS

- n. 1 shelf in smoked grey glass, 10 mm thick, height adjustable by +/- 3,2 cm.

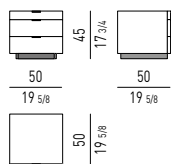

### ATTREZZATURE CASSETTI

Cassetto superiore cm H8 con scomparti utilizzo svuotatasche; cassetti inferiori cm H16.

### DRAWER ACCESSORIES

Upper drawer H8 cm with spaces to pocket empty, lower drawers H16 cm.

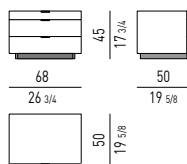
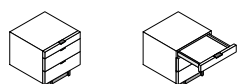

### ATTREZZATURE CASSETTI

Cassetto superiore cm H8 con scomparti utilizzo svuotatasche; cassetti inferiori cm H16.

### DRAWER ACCESSORIES

Upper drawer H8 cm with spaces to pocket empty, lower drawers H16 cm.

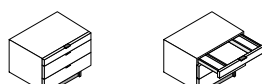

## HARVEY LINE HI-FI H53

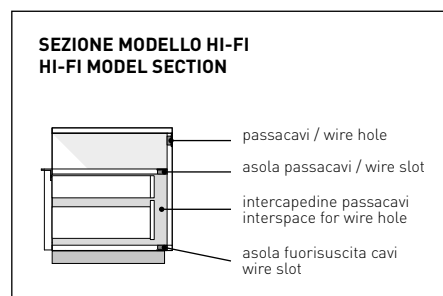
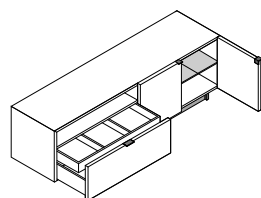
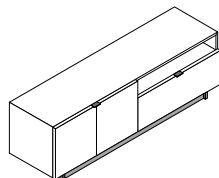
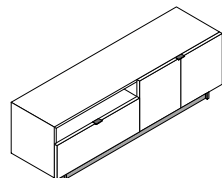
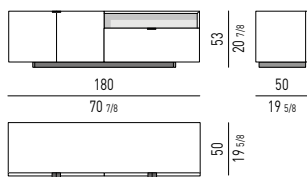
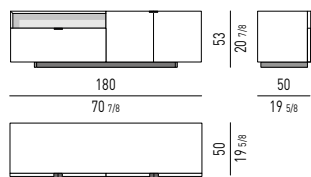
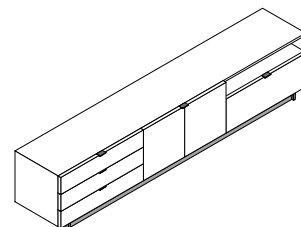
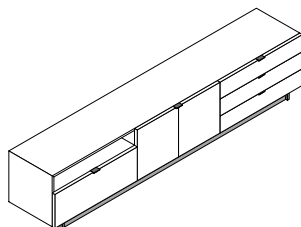
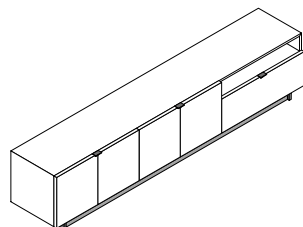
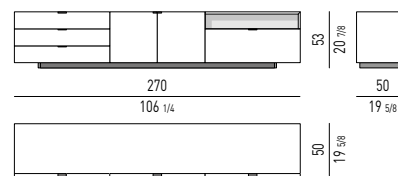
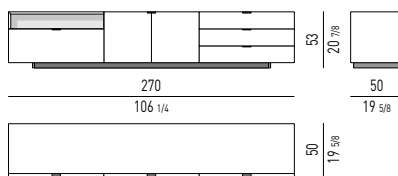
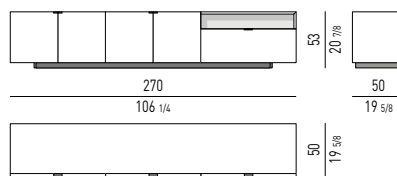
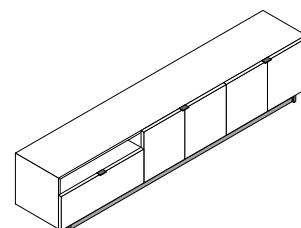
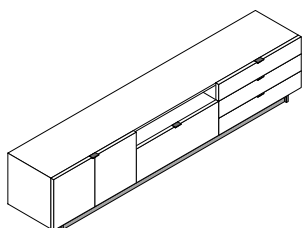
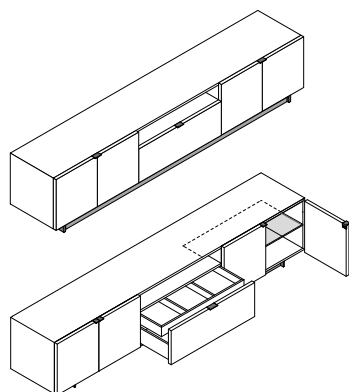
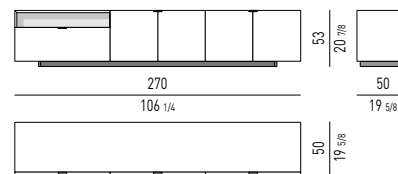
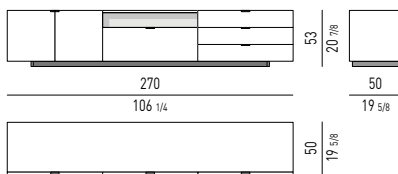
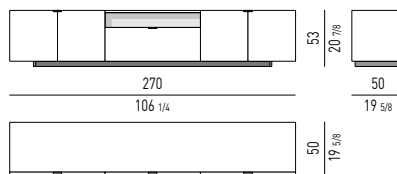

### ATTREZZATURA INTERNA

- ripiano in vetro grigio fumé, inserito nell'elemento con ante, spessore 10 mm, regolabile in altezza di +/- 3,2 cm;
- vano porta lettore DVD/CD, misura interna cm 90x45 H14;
- cassetto cm 90x32, portata Kg 30, misura interna cm 86x37 H12;
- cassetto interno in legno, a 3 comparti, misura interna cm 27x37 H6.

### INTERIOR ACCESSORIES

- shelf in smoked grey glass, inserted in the unit with doors, 10 mm thick, height adjustable by +/- 3.2 cm;
- DVD/CD compartment, interior dimensions 90x45 H14 cm;
- drawer 90x32 cm, max load Kg 30, interior dimensions 86x37 H12 cm;
- interior wood drawer, with 3 compartments, interior dimensions 27x37 H6 cm.

### PASSACAVI | CABLE MANAGEMENT



## ELEMENTI HARVEY LINE | HARVEY LINE ELEMENTS



CM 180X50 H53  
INCHES 70<sup>7/8</sup>X19<sup>5/8</sup> H20<sup>7/8</sup>



CM 180X50 H53  
INCHES 70<sup>7/8</sup>X19<sup>5/8</sup> H20<sup>7/8</sup>



CM 270X50 H53  
INCHES 106<sup>1/4</sup>X19<sup>5/8</sup> H20<sup>7/8</sup>



CM 270X50 H53  
INCHES 106<sup>1/4</sup>X19<sup>5/8</sup> H20<sup>7/8</sup>



CM 180X50 H74  
INCHES 70<sup>7/8</sup>X19<sup>5/8</sup> H29<sup>1/8</sup>



CM 180X50 H74  
INCHES 70<sup>7/8</sup>X19<sup>5/8</sup> H29<sup>1/8</sup>



CM 270X50 H74  
INCHES 106<sup>1/4</sup>X19<sup>5/8</sup> H29<sup>1/8</sup>



CM 270X50 H74  
INCHES 106<sup>1/4</sup>X19<sup>5/8</sup> H29<sup>1/8</sup>

# Minotti



CM 180X50 H53  
INCHES 70<sup>7/8</sup>X19<sup>5/8</sup> H20<sup>7/8</sup>



CM 270X50 H53  
INCHES 106<sup>1/4</sup>X19<sup>5/8</sup> H20<sup>7/8</sup>

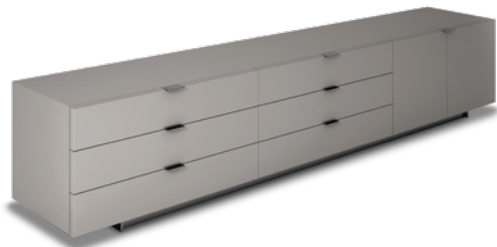

CM 270X50 H53  
INCHES 106<sup>1/4</sup>X19<sup>5/8</sup> H20<sup>7/8</sup>

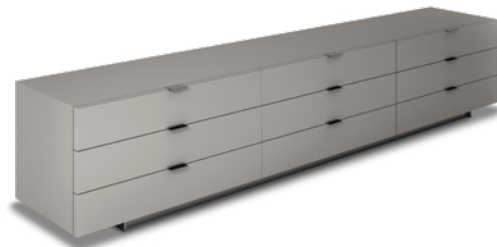

CM 270X50 H53  
INCHES 106<sup>1/4</sup>X19<sup>5/8</sup> H20<sup>7/8</sup>



CM 180X50 H74  
INCHES 70<sup>7/8</sup>X19<sup>5/8</sup> H29<sup>1/8</sup>



CM 225X50 H74  
INCHES 88<sup>5/8</sup>X19<sup>5/8</sup> H29<sup>1/8</sup>



CM 270X50 H74  
INCHES 106<sup>1/4</sup>X19<sup>5/8</sup> H29<sup>1/8</sup>



CM 90X50 H101  
INCHES 35<sup>3/8</sup>X19<sup>5/8</sup> H39<sup>3/4</sup>



## ELEMENTI HARVEY LINE | HARVEY LINE ELEMENTS



CM 90X50 H101  
INCHES 35<sup>3</sup>/<sub>8</sub>X19<sup>5</sup>/<sub>8</sub> H39<sup>3</sup>/<sub>4</sub>



CM 90X50 H101  
INCHES 35<sup>3</sup>/<sub>8</sub>X19<sup>5</sup>/<sub>8</sub> H39<sup>3</sup>/<sub>4</sub>



CM 180X50 H53  
INCHES 70<sup>7</sup>/<sub>8</sub>X19<sup>5</sup>/<sub>8</sub> H20<sup>7</sup>/<sub>8</sub>



CM 270X50 H53  
INCHES 106<sup>1</sup>/<sub>4</sub>X19<sup>5</sup>/<sub>8</sub> H20<sup>7</sup>/<sub>8</sub>



CM 270X50 H53  
INCHES 106<sup>1</sup>/<sub>4</sub>X19<sup>5</sup>/<sub>8</sub> H20<sup>7</sup>/<sub>8</sub>



CM 68X50 H45  
INCHES 26<sup>3</sup>/<sub>4</sub>X19<sup>5</sup>/<sub>8</sub> H17<sup>3</sup>/<sub>4</sub>



CM 50X50 H45  
INCHES 19<sup>5</sup>/<sub>8</sub>X19<sup>5</sup>/<sub>8</sub> H17<sup>3</sup>/<sub>4</sub>



CM 270X50 H53  
INCHES 106<sup>1</sup>/<sub>4</sub>X19<sup>5</sup>/<sub>8</sub> H20<sup>7</sup>/<sub>8</sub>



CM 270X50 H53  
INCHES 106<sup>1</sup>/<sub>4</sub>X19<sup>5</sup>/<sub>8</sub> H20<sup>7</sup>/<sub>8</sub>